

GE
Grid Solutions

Surge Protection for AC Rotating Machines

Capacitors, TRANQUELL™ Arresters
and Motor Surge Equipment



Product Selection & Application Guide

GE Surge Protection Capacitors & Equipment

Protective capacitors offer surge protection for AC generators, synchronous condensers and large motors. Surge capacitors protect the winding insulation by reducing the steepness of wave fronts applied to or reflected within the machine windings. Dielektrol™ is the GE non-PCB power capacitor dielectric fluid developed to provide an environmentally acceptable product with superior performance and reliability. GE protective capacitors contain an all film dielectric system and hermetically sealed bushings, which permit mounting these capacitors upright or on their side.

GE TRANQUELL Arresters when utilized with GE Surge capacitors provide additional security for AC rotating machines. Arresters provide a reduction of lightning stresses by limiting the amplitude of applied impulse waves or reflections within the machine windings.

GE provides the complete assembly solution suitable for indoor or outdoor applications. GE can also provide individual capacitor(s) and arresters for individual application requirements.

18L Series Protective Capacitors

38F Series Motor Surge Protection



Table of Contents

Introduction-Protective Capacitors.....	3
Product Table-Protective Capacitors.....	3
Altitude De-Rating-Protective Capacitors	4
Guide for Superseded Part Numbers-Protective Capacitors	4
Application Guide-Protective Capacitors.....	5
Motor Surge Protection Product Selection Process.....	5
Product Drawings	6

Introduction – Protective Capacitors

Dielektrol Non-PCB Protective Capacitors with Internal Discharge Resistors Indoor or Outdoor Application

Product Description, Features & Benefits

- Surge protection for AC generators, synchronous condensers and large motors
- Time proven GE dielectric system
- Dielektrol Non-PCB insulating fluid
- Provides turn-to-turn insulation protection by reducing steepness of wave fronts applied to or reflected within the machine
- Used in combination with TRANQUELL GE station arresters for optimum protection
- Protective capacitors contain a film dielectric and hermetically sealed bushings, which permit mounting of the capacitors in an upright position or on their side¹
- Altitude 0 to 15000²

Note 1: Upside down mounting is allowed for 18L0060WH, 18L0061WH and 18L0062WH only. See product table for rating details.

Note 2: See Altitude de-rating table for de-rating of application voltage.

Product Table

Voltage Rating rms Volts L-L *	Maximum Voltage rms Volts L-L	Catalog number	Poles per Unit	Microfarads per Pole	Approximate net weight		Drawing
					lbs	kg	
0 - 650	715	9L18BBB301	3	1.0	4	18	A
2400	2640	18L0015WH	3	0.5	36	16.5	4
4160	4576	18L0015WH	3	0.5	36	16.5	4
6900	7590	18L0019WH	1	0.5	29	13	1
7200	7960	18L0065WH	3	0.5	35	16	5
13800	15180	18L0009WH	1	0.25	33	15	2
13800	15180	18L0012WH	3	0.25	66	30	6
24000	26400	18L0010WH	1	0.125	57	26	3
24940	-	18L0070WH	1	0.25	75	34	10
750 *	-	18L0004WH	1	4.0	12	5.5	9
3900 *	-	18L0005WH	1	4.0	46	20.9	8
13800	15180	18L0051WH	1	0.05	49	22.3	11
13800	15180	18L0060WH ¹	1	0.25	32	14.5	2
6900	7590	18L0061WH ¹	1	0.5	30	13.6	1
4160	4576	18L0062WH ¹	3	0.5	36	16.4	4

* 18L0004WH and 18L0005WH are rated for DC Applications

¹ Units are rated for inverted mounting

² For other mounting arrangements contact factory

³ 2400 and 4160 volt rated designs are identical and use the same catalog number

⁴ All AC capacitor units are CSA labeled

Altitude De-Rating – Protective Capacitor

Altitude De-Rating of Capacitors Above 3,300 ft (1,000 m)

Altitude		Altitude Correction (1)
(ft)	(m)	
3,300	1000	1.00
4,000	1200	0.98
5,000	1500	0.95
6,000	1800	0.92
7,000	2100	0.89
8,000	2400	0.86
9,000	2700	0.83
10,000	3000	0.80
12,000	3600	0.75
14,000	4200	0.70
15,000	4500	0.67

¹ Multiplier X rated voltage for reduced application voltage at the given altitude

Guide for Superseded Models

Old Part Number	Current Part Number	Capacitor Voltage Rating	Number of Poles
18F107	18L0015WH	4160	3
18F107G3	18L0019WH	4160	1
18F26	18L0019WH	2400	1
18F26G2	18L0019WH	2400	1
18F27	Discontinued	2400	2
18F270G2	18L0010WH	24000	1
18F27G2	Discontinued	2400	2
18F28	18L0015WH	2400	3
18F29	18L0019WH	4800	1
18F29G2	18L0019WH	4800	1
18F30	18L0019WH	6900	1
18F30G2	18L0019WH	6900	1
18F35	Discontinued	11500	1
18F35G2	Discontinued	11500	1
18F451	18L0009WH	13800	1
18F451G5	18L0009WH	13800	1
18F467	18L0010WH	24000	1
18F58	18L0015WH	4160	3
18F585	18L0015WH	2400	3
18F586	18L0015WH	4160	3
18F59	18L0009WH	13800	1
18L10RH	18L0010WH	24000	1
18L10WH	18L0010WH	24000	1
18L15RH2	18L0015WH	4160	3
18L15RJ2	18L0065WH	7200	3
18L15UJ	18L0015WH	4160	3
18L15WH	18L0015WH	4160	3

Old Part Number	Current Part Number	Capacitor Voltage Rating	Number of Poles
18L15WH	18L0015WH	2400	3
18L19RH	18L0019WH	6900	1
18L19UH	18L0019WH	6900	1
18L19WH	18L0019WH	6900	1
18L65UH	18L0065WH	7200	3
18L65WH	18L0065WH	7200	3
18L6RH2	18L0015WH	2400	3
18L9RH	18L0009WH	13800	1
18L9UH	18L0009WH	13800	1
18L9WH	18L0009WH	13800	1
9CL1B20	18L0015WH	2400	3
9CL1B22	18L0019WH	4800	1
9CL1B23	18L0019WH	6900	1
9CL1B24	Discontinued	11500	1
9CL1B25	18L0009WH	13800	1
9L18ACE101	18L0019WH	2400	1
9L18ACE201	Discontinued	2400	2
9L18ACE301	18L0015WH	2400	3
9L18ACG101	18L0019WH	4160	1
9L18ACG301	18L0015WH	4160	3
9L18ACH101	18L0019WH	4800	1
9L18ACH301	Discontinued	4800	3
9L18ACJ101	18L0019WH	6900	1
9L18ACK101	Discontinued	11500	1
9L18ACL101	18L0009WH	13800	1
9L18ACM101	18L0010WH	24000	1
9L18BCE301	18L0015WH	2400	3

Old Part Number	Current Part Number	Capacitor Voltage Rating	Number of Poles
9L18BCG301	18L0015WH	4160	3
9L18BCG302	18L0065WH	7200	3
9L18BCJ101	18L0019WH	6900	1
9L18BCL101	18L0009WH	13800	1
9L18BCM101	18L0010WH	24000	1
9L18CCE301	18L0015WH	2400	3
9L18CCG301	18L0015WH	4160	3
9L18CCG302	18L0065WH	7200	3
9L18CCJ101	18L0019WH	6900	1
9L18CCJ301	18L0015WH	6900	3
9L18CCL101	18L0009WH	13800	1
9L18CCM101	18L0010WH	24000	1
9L18DCE301	18L0015WH	2400	3
9L18DCG301	18L0015WH	4160	3
9L18DCG302	18L0065WH	7200	3
9L18DCJ101	18L0019WH	6900	1
9L18DCL101	18L0009WH	13800	1
9L18DCM101	18L0010WH	24000	1
9L18DCM102	18L0010WH	24000	1
9L18ECE301	18L0015WH	2400	3
9L18ECG301	18L0015WH	4160	3
9L18ECG302	18L0065WH	7200	3
9L18ECJ101	18L0019WH	6900	1
9L18FCG301	18L0015WH	4160	3
9L18FCG302	18L0065WH	7200	3
9LA6A29	Discontinued	300	
9LA6B1	18L0010WH	24000	1

Application Guide – Protective Capacitors

Application Information

GE Dielektrol Surge Capacitors and TRANQUELL Motor Surge Protectors can be applied directly at the motor or generator terminals to reduce the potential for damage caused by lightning and or switching surges.

GE Surge Protective Capacitors reduce the steepness of wave fronts to protect turn to turn insulation from surges applied to or reflected within machine windings.

GE TRANQUELL Motor Surge Protectors utilize GE TRANQUELL Surge Arresters applied in parallel with GE Dielektrol Surge Capacitors. When applied together, the arresters protect the major insulation to ground by limiting the amplitude of applied impulse waves or reflections within the machine windings, while the protective capacitor(s) reduce the steepness of the wave fronts. Studies indicate that this dual protection approach results in significant reduction of lightning stresses imposed on rotating machines and contribute to increased security against failures and downtime costs. The enclosures are suitable for indoor and outdoor applications. (See Figure 1).

Figure 1

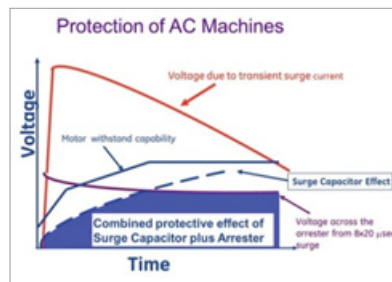

TRANQUELL Motor Surge Protection Product Selection Process

1. Determine the nominal system voltage and connection at the equipment being protected (Line-to-Line, delta or wye, grounded or ungrounded).
2. Select product from the Selection Table (catalog number from columns 2 or 3, based upon line-to-line voltage in column 1).

Voltage Rating rms Volts (L-L)	Catalog Number for Delta & Ungrounded Neutral Systems	Catalog Number for Grounded Neutral Systems	Arrester Rating kV rms	Arrester MCOV kV rms	Capacitor Microfarads per Pole μF	Dimension "D" (side view in inches) ¹	Weight in lbs.
2400	38F2401	—	3	2.55	0.5	23	300
4160	38F2402	—	6	5.1	0.5	23	300
—	—	38F2403	3	2.55	0.5	23	300
4800	38F2404	—	6	5.1	0.5	23	300
6900	38F2405	—	9	7.65	0.5	23	300
7200	38F2406	—	9	7.65	0.5	23	300
13200	38F2407	—	18	15.3	0.25	23	300
—	—	38F2408	10	8.4	0.25	23	300
13800	38F2409	—	18	15.3	0.25	23	300
—	—	38F2410	12	10.2	0.25	23	300
24000	38F2411	—	27	22	0.125	36	350
—	—	38F2412	21	17	0.125	36	350

¹ See drawing 7 for detail

Product Drawings

Drawing 1:
Single-Pole, 6,900 volts

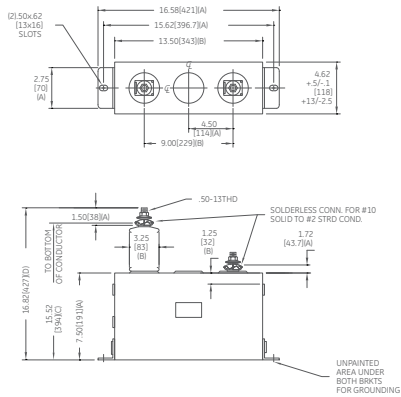

Drawing 2:
Single-Pole, 13,800 volts

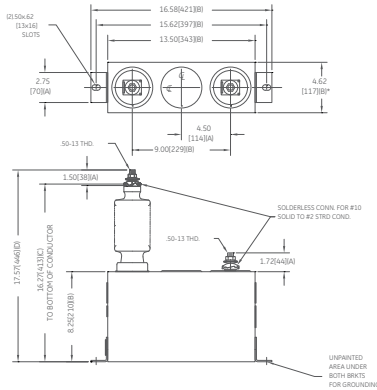

Drawing 3:
Single-Pole, 24,000 volts

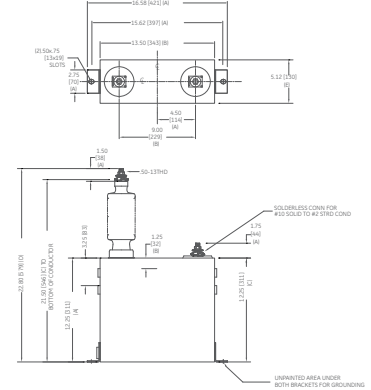

Drawing 4:
Three-Poles, 2,400 & 4,160 volts

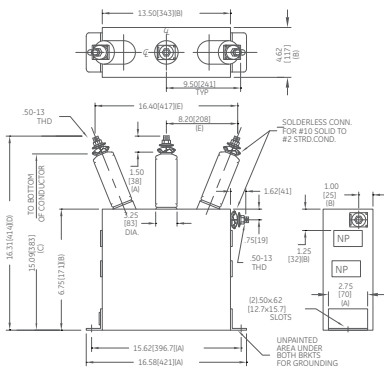

Drawing 5:
Three-Poles, 7,200 volts

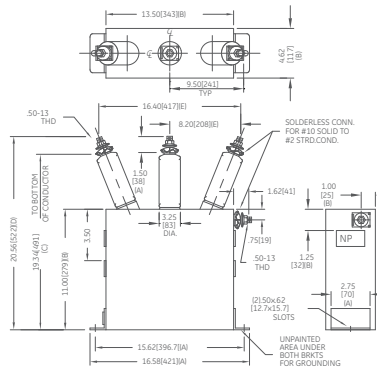

Drawing 6:
Three-Poles, 13,800 volts

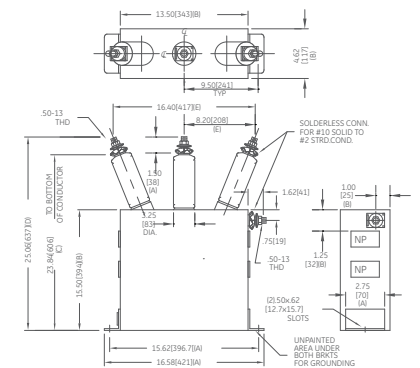

Drawing 7:
38F series

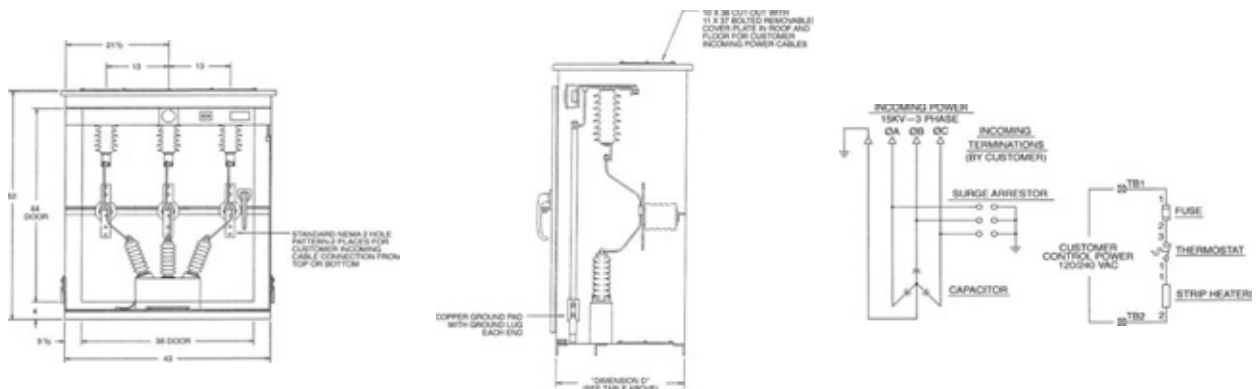

Product Drawings

Drawing 8:
3,900 volts DC

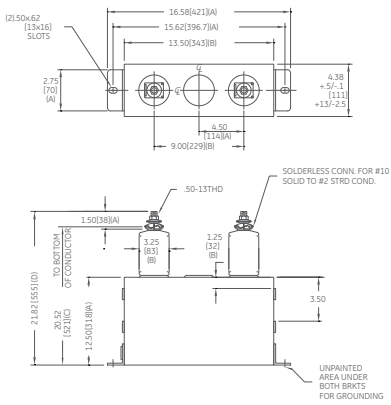

Drawing 9:
750 volts DC

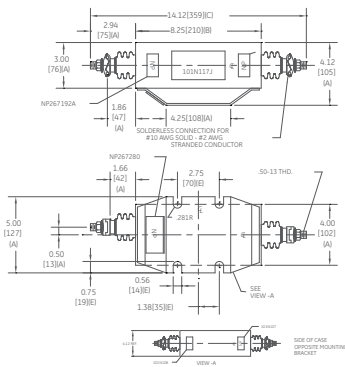

Drawing 10:
Single-Pole, 24,940 volts

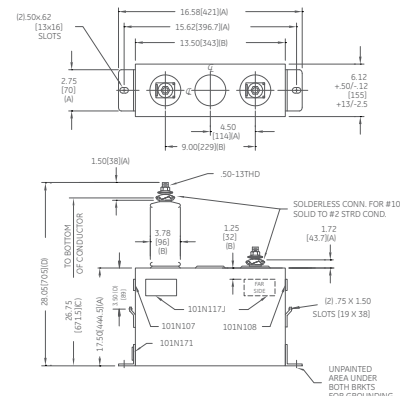

Drawing 11:
Single-Pole, 13,800 volts

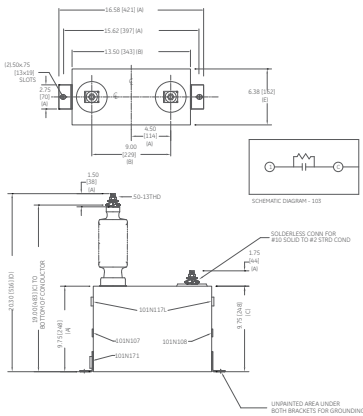

Drawing A:
Three-Pole, 0-650 volts

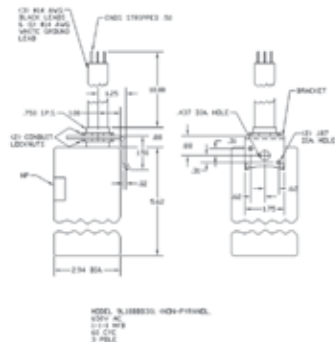

- GE 18L surge capacitor terminals are supplied with solderless connectors for #10 solid to #2 stranded conductors.
- Information nameplates are stainless steel also with CSA and non-PCB labels,

